

# 2024 X-TREME NINJA COURSE 1







See Adam Rayl run through  
an X-treme Ninja course

SCAN THE CODE OR VISIT  
[GREENFIELDSFITNESS.COM  
/X-TREME-NINJA-COURSE](https://www.greenfieldsfitness.com/x-treme-ninja-course)

**REQUIRED AREA:**  
70' x 33'  
**FEATURES: 12**

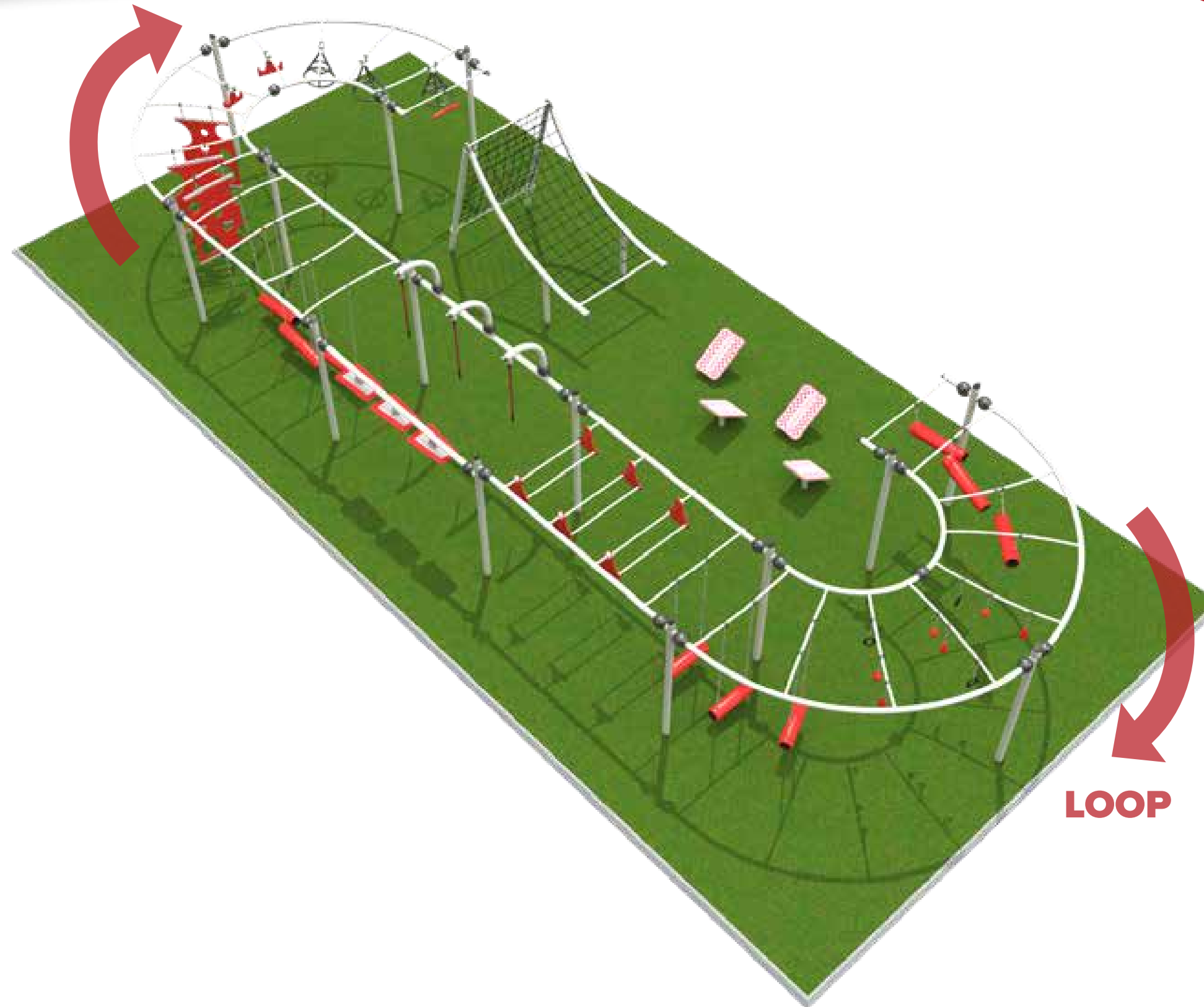

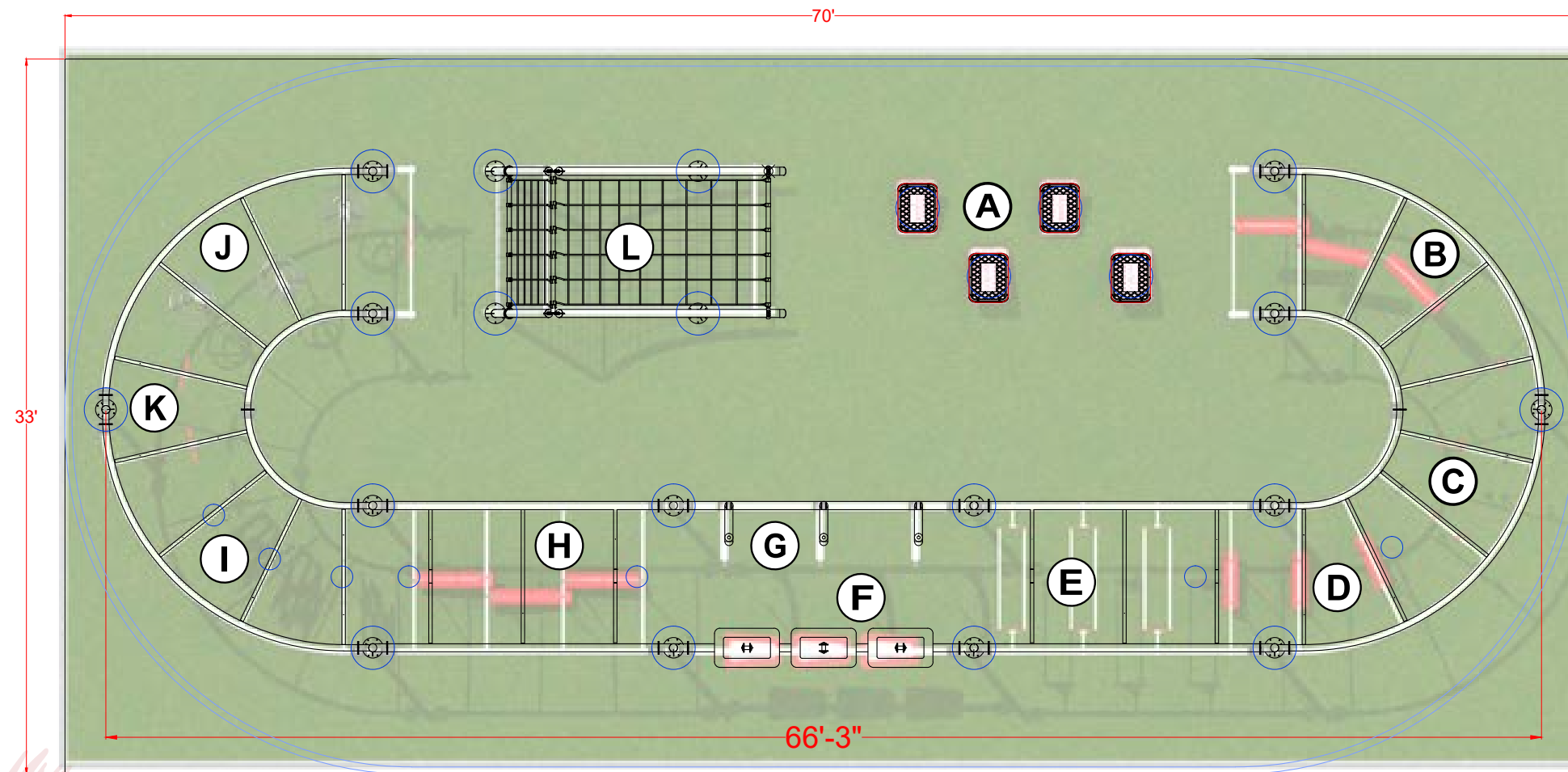

## COURSE FEATURES:

<b>A</b>	Slanted Jump Boards	NJ-501
<b>B</b>	Spider Walk	NJ-515
<b>C</b>	Cones, Grip Balls, & Rings	NJ-5234
<b>D</b>	Burmese Floating Bridge	NJ-514
<b>E</b>	Toggle Pull-Up Triangles	NJ-521
<b>F</b>	Hanging Platforms	NJ-528
<b>G</b>	Swinging Rope	NJ-506
<b>H</b>	Hovering Beam	NJ-519
<b>I</b>	Cheese Walls	NJ-508
<b>J</b>	Rotating Cone Wheels	NJ-513
<b>K</b>	Swings	NJ-518
<b>L</b>	Spider Web Climber	NJ-512

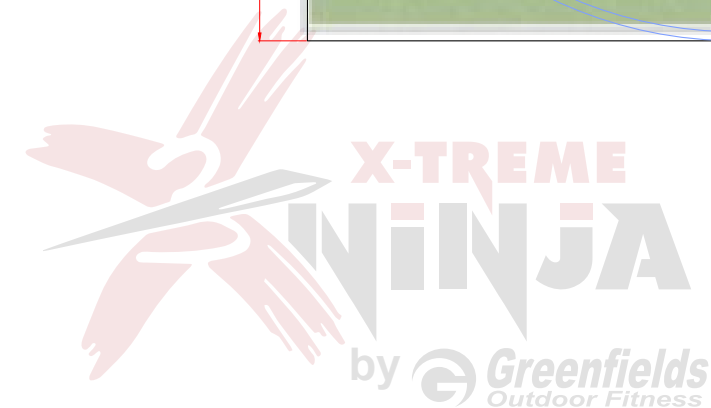

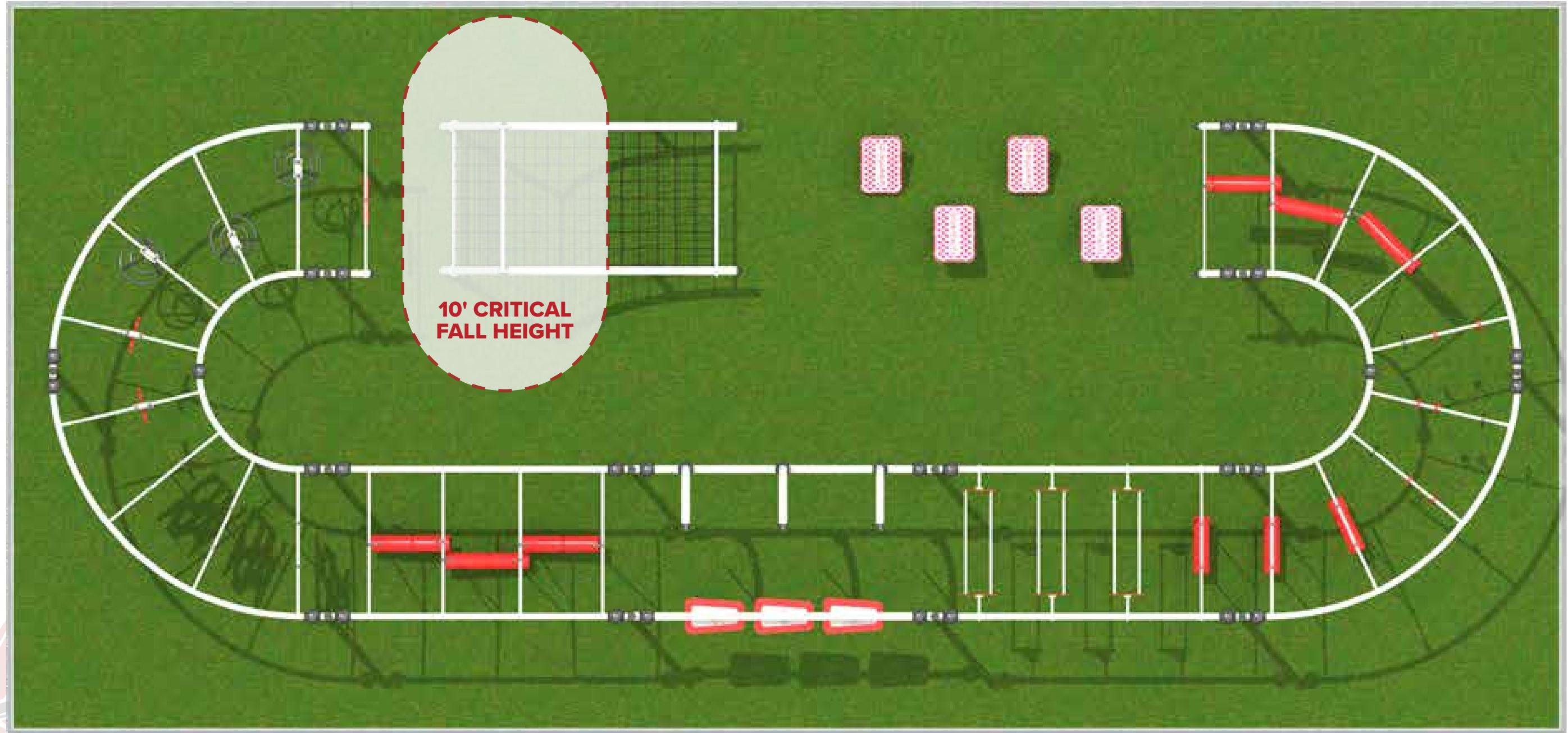

**10' CRITICAL  
FALL HEIGHT**

**SPIDER WALK**

NJ-515

**B**



**G**

**SWINGING ROPE**

NJ-506



**RINGS, GRIP BALLS, & CONES**

NJ-5234



**C**



**A**

**SLANTED JUMP BOARDS**

NJ-501 Outdoor Fitness



**D**

**BURMESE FLOATING BRIDGE**

**NJ-514**



**E**

**TOGGLE PULL-UP TRIANGLES**

**NJ-521**



**H**

**HOVERING BEAM**

**NJ-519**



**J**

**ROTATING CONE RINGS**

**NJ-513**



**F**

**HANGING PLATFORMS**

**NJ-528**





**SWING**  
NJ-518

**SPIDER WEB**  
NJ-512

**CHEESE WALLS**  
NJ-508



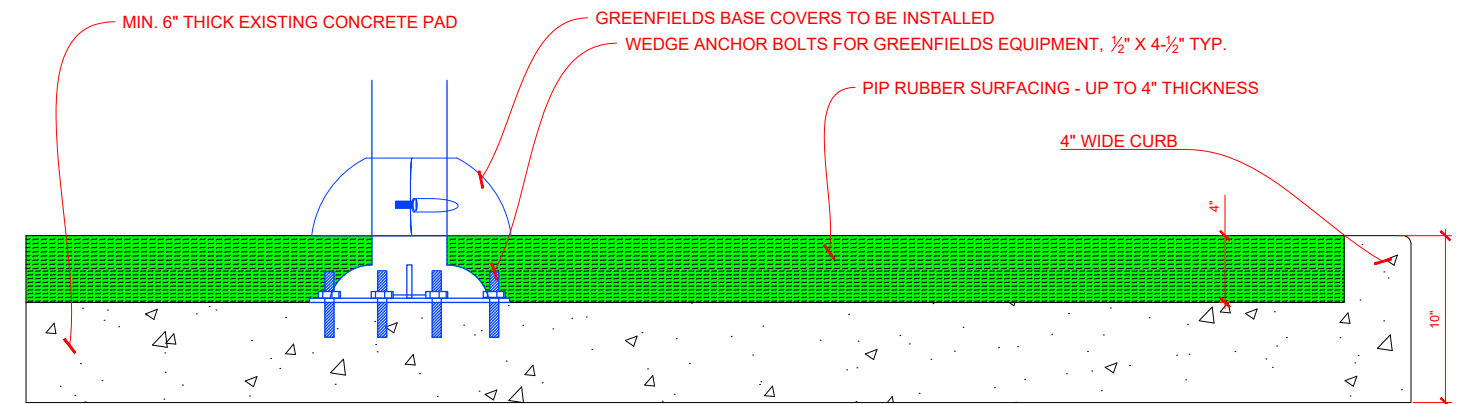
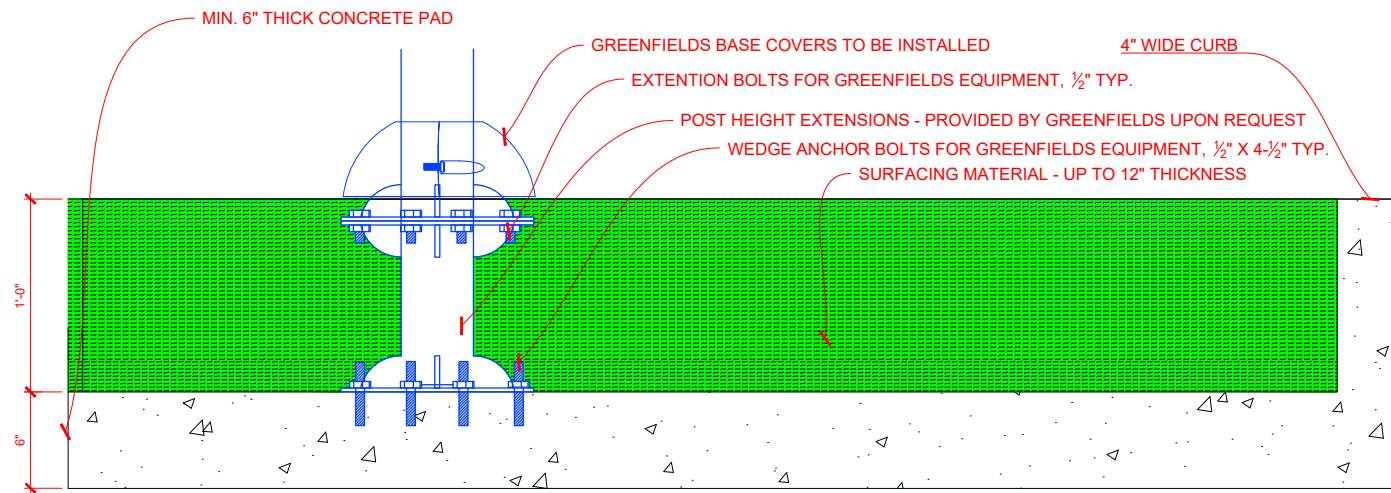

**SURFACING OPTION 1**

**X-TREME NINJA**  
12" MULCH

**SURFACING OPTION 2**

4" PIP



**MULCH SURFACING**



**PIP SURFACING**



**TURF SURFACING**

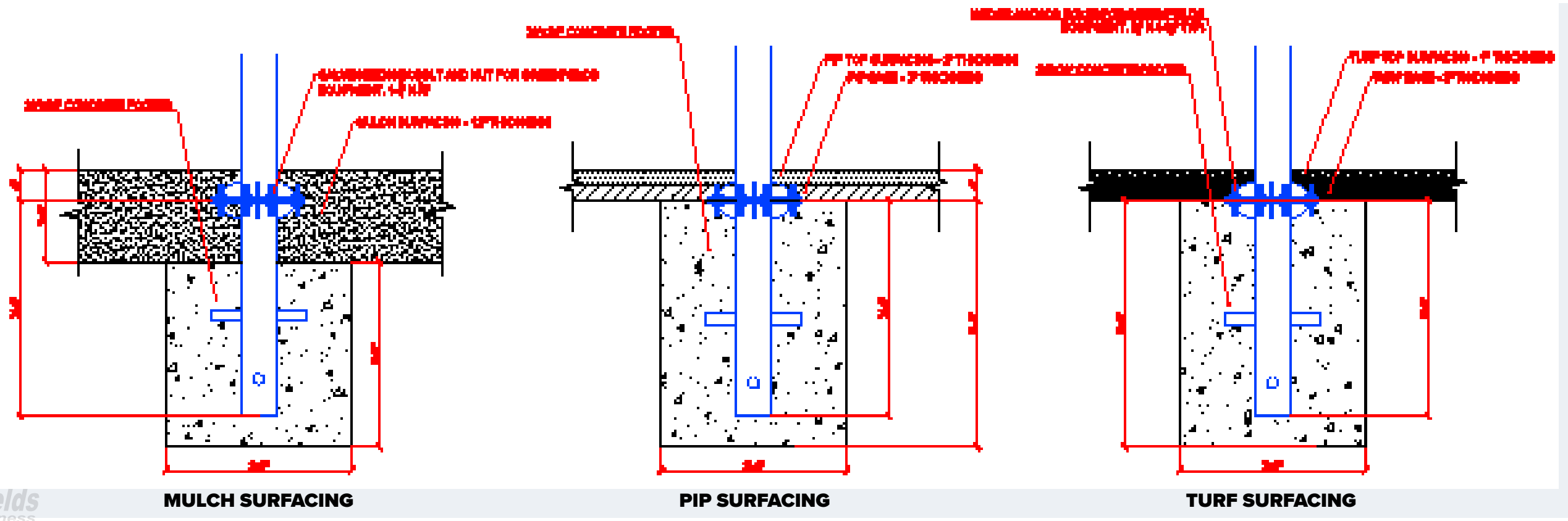

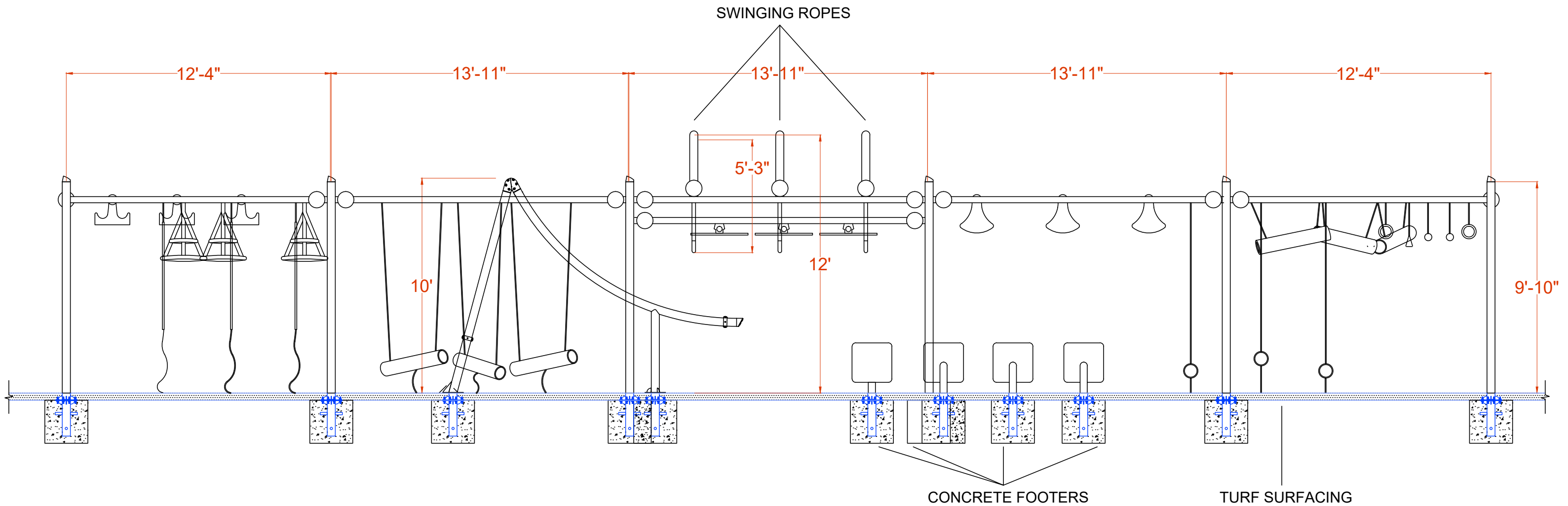

## COURSE ELEVATIONS





# ENHANCE YOUR PACKAGE!

Greenfields offers these products and more for the best user experience



Benches



Trash Receptacles



Bike Racks



**What's underneath?**  
Integrated lighting allows for use well into the evening.

## SHADE OPTIONS

Designed to fit your project's unique needs



Shade sails



Multi-level shade



Shade canopy

# THE GREENFIELDS OUTDOOR FITNESS APP

The Greenfields App is the perfect companion to our multigenerational outdoor gyms, giving users the ability to search for gyms near their location, explore exercises available on Greenfields units, create workouts, and log their progress.

Now available on iOS and Android.



[greenfieldsfitness.com/app-download/](https://greenfieldsfitness.com/app-download/)

## EXPLORE

Search for gyms near you.



## WORKOUT

Customize your routine.

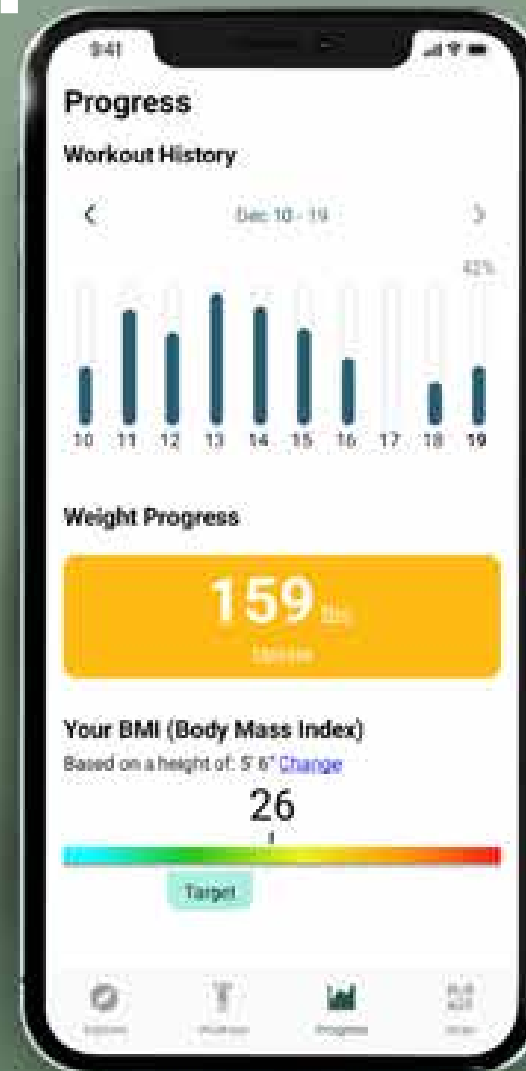
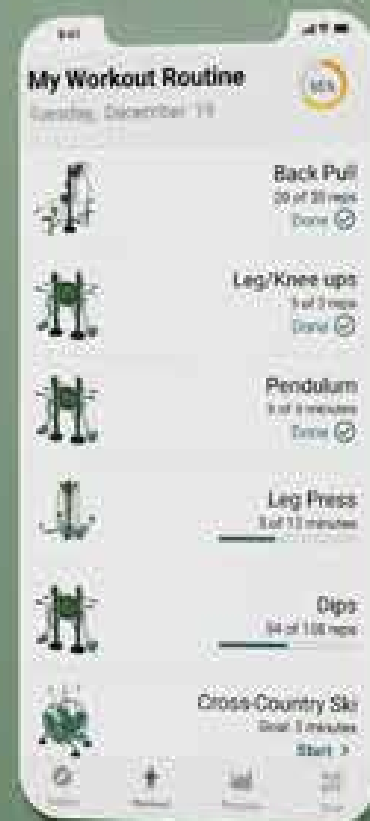

## SCAN

Quickly find videos & more.

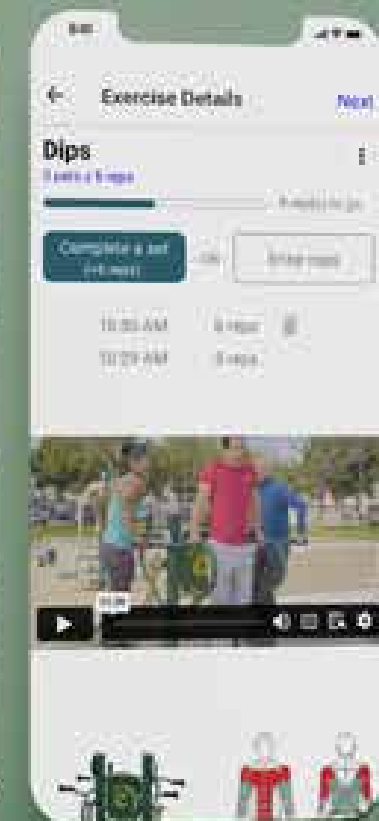

**General Installation Instructions:**

# Surface Mount



The following information for contractors, maintenance personnel and supervisory staff will help ensure an accurate, safe and problem-free

Questions? Please call 888-315-9037 x105

installation. **UNITS ARE HEAVY** (up to 450 lbs.) When unloading and handling, please exercise extra care to prevent injury or damage to the equipment. For installation, epoxy is **not** included in shipment and must be provided by installer.



Video Demo: <http://www.greenfieldsfitness.com/surface-mount-installation/>

**Tools Needed:** **Concrete pad must be fully cured before anchoring begins.**

1. Concrete drill
2. 1/2" carbide tipped drillbit
3. Angle grinder
4. Compressor with blow tip
5. Sledge hammer
6. 3/4" socket
7. Torque wrench

**Parts Included:**

Wedge Anchors - 4 1/2" x 1/2"

Black Plastic Covers

Black Plastic Caps

Metal Shims

**Specifications:**

- Concrete: 3250 PSI (minimum)
- Aggregate mix: 1:3 3/8" to 3/4"
- Concrete mix: 1:3:2.5 concrete, aggregate, and sand mix
- #3 rebar with 12" spacing
- When pouring a single pad for multiple units, use **concrete thickness 6"**
- When pouring standalone pads, **concrete thickness minimum 8"**
- Bolt Size: 1/2"
- Bolt Length: 4-1/2" (minimum)
- Hardware: Wedge Anchor Stainless Steel
- Minimum embed depth: 3-1/2"

**Basic Installation Guidelines:**



1. Place unit on concrete pad and mark holes. Mark all holes. Make a mark on the unit and the ground to make sure unit lines up with holes.



2. Drill all holes with concrete drill. Drill to a depth of 5-6" deep.



3. Using compressor or blower, blow out concrete dust from holes.



4. Fill holes with epoxy, making sure not to overflow. (Epoxy is **not** included in shipment and must be provided by installer).

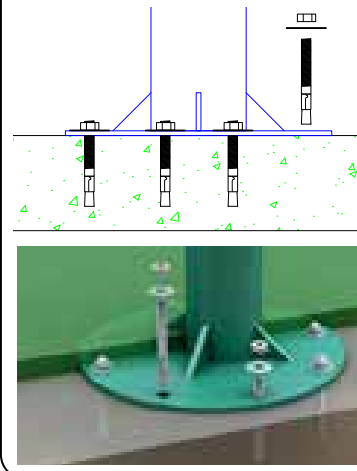

In order to honor our commitment to quality and safety, Greenfields Outdoor Fitness reserves the right to make changes and revise the design specifications without notice. LU21x03x24 © 2020 Greenfields Outdoor Fitness, Inc.

**General Installation Instructions:**

# Surface Mount



The following information for contractors, maintenance personnel and supervisory staff will help ensure an accurate, safe and problem-free installation.

Questions? Please call 888-315-9037 x105

**Basic Installation Guidelines (cont'd)**

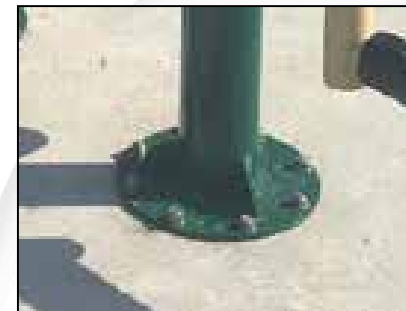

5. Place unit over holes and make sure it lines up with mark.
6. Thread nuts onto anchors just until they are flush with the top of the anchors.
7. Hammer anchors into holes.
8. Install shims to plumb posts.
9. Tighten anchors until snug, and wait 24 hours to tighten to 80-90ft/lbs.
10. Cut off extra bolt length, if any.
11. Follow unit-specific installation instructions for installation of base plate covers and black caps.





## General Installation Instructions: In-Ground Embedded Footings



Video Demo:  
<https://gfoutdoorfitness.com/in-ground-installation/>

The following information for contractors, maintenance personnel and supervisory staff will help ensure an accurate, safe and problem-free installation.



### SUGGESTED MATERIALS

Please be advised that the use of decomposed granite surfacing (DGS) is known to accelerate normal wear & tear of footrests.

1. 2x4s: approximately four, 8' to 10' lengths per unit.
2. All-Thread: 3/8" to 1/2", cut in 1' lengths, two pieces per embedded pipe.
3. Nuts & Washers: to fit all-thread, four sets per embedded pipe.
4. Stakes: metal/wood, approximately six per unit.
5. Pavers/Cinder Blocks: 1 to 2 per unit.
6. Tie Wire/C-Clamps
7. Duplex Wood Nails/Dry Wall Screws
8. Concrete: 3250 psi or better. Aggregate ratio: 3/8" to 3/4" in 1:3 ratio. Concrete ratio: 1:3:2.5 of concrete, aggregate, and sand.
9. Tools: cordless impact driver, skill saw, pliers, hammer, small sledge, magnetic level, tape measure, shovels, wheelbarrows, etc.
10. Plans/Drawings: schematic drawings and instructions for each model # to be installed.

### SITE PREP - Before equipment handling

1. Area should be fenced—recommend 6' temporary fencing, entire perimeter.
2. Ground should be thoroughly graded and "finished grade" accurately established, using either laser or string-line methods.
3. Prior to digging, entire site should be "laid-out" with all footings clearly marked as per plans.
4. In the U.S. contact "Dig Alert" for clearance to dig, and follow all local construction regulations (fencing, dirt removal, etc.)
5. Dig footings, closely following given dimensions.
6. Remove dirt and debris from site, prior to placing units.



## General Installation Instructions: In-Ground Embedded Footings



### BASIC INSTALLATION GUIDELINES

**UNITS ARE HEAVY** (up to 450 lbs.) When unloading and handling, please exercise extra care to prevent injury or damage to the equipment.

1. All units must be fully assembled before installation.
2. All screws must be attached using LocTite.
3. Do not drag units along the ground.
4. If missing parts or damaged items are noticed during installation, or should any assistance be required, please contact Greenfields immediately at 888-315-9037 x105.
5. All units **MUST** be fully assembled, leveled, and braced in place in the footing hole before any concrete is poured.
6. A monolithic pour **MUST** be used for concrete. (All concrete must be poured at one time.)
7. Concrete requirement: 3250 psi or better.
8. The top of the blue tape attached to the posts on the equipment is final top surface level.
9. Brace units at the designated locations using the 2x4s, secured by c-clamps, all-thread or tie-wire. Use padding to avoid scratching powder coating.
10. Suggested safety zone is about 48" - 60" perimeter around usage area (seats and moving parts). Clearance area may overlap with a nearby unit, as long as there is enough clearance to safely mount and dismount each unit.
11. Make sure all units are plumb and leveled. Adhere to surfacing level (marked on units with blue tape).
12. Pour concrete.
13. Clear concrete residue from post and other parts.
14. Let concrete dry. It is recommended to wait a minimum of one week after concrete is poured before equipment is used.
15. Remove supports.
16. Touch up units using attached guide.
17. Wrap units in black tarps until open to public.
18. At the end of installation, toolbox and all documentation should be submitted to the local maintenance staff.



# SURFACE MOUNT WITH PIP DRAINAGE OPTIONS

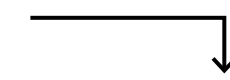

**French Drain #1**



**Curb Cutouts**



**PIP Wrap-Around**



**French Drain #2**

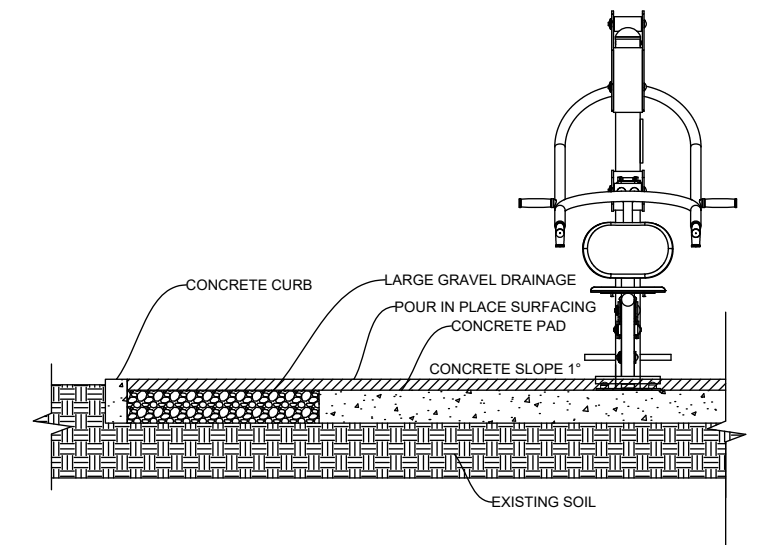
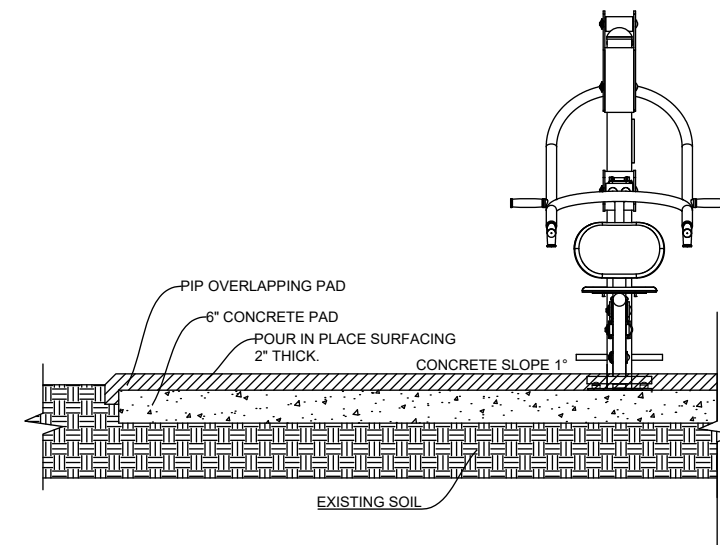
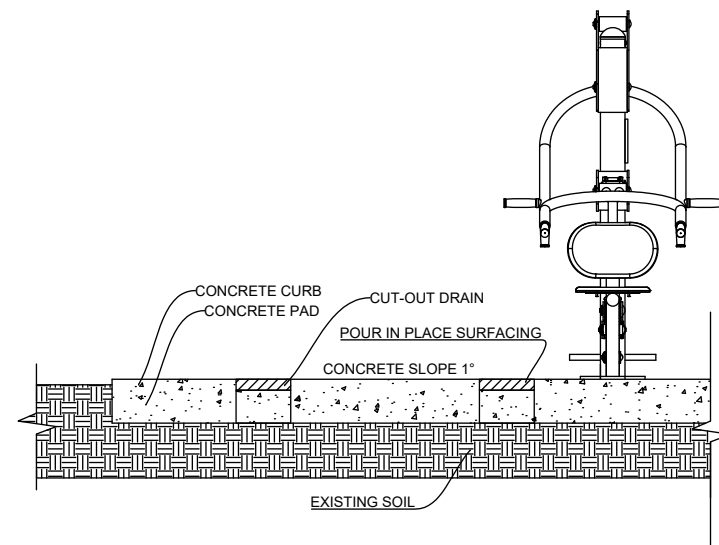
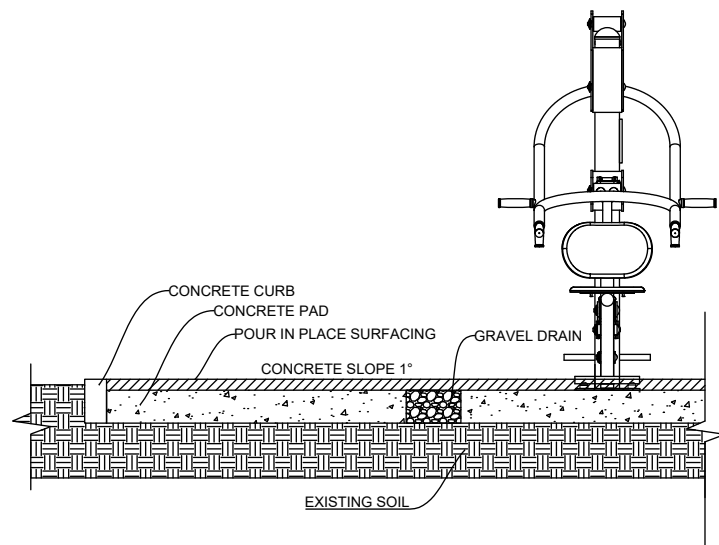

## Inspection Checklist

### General Guidelines for Outdoor Fitness Equipment



Questions? Please call 888-315-9037 x105

The following document is supplied as a general inspection document to be performed during regular park inspections. Our support team can be reached at (888) 315-9037 x105 or [csc@greenfieldsfitness.com](mailto:csc@greenfieldsfitness.com).

#### Inspection process

- |  |  |
|--|--|
| <input type="checkbox"/> Visual Inspection   | <input type="checkbox"/> Documentation |
| <input type="checkbox"/> Internal Inspection | <input type="checkbox"/> Reporting     |

#### Visual Inspection

- Check all plastic footrests, backrests, seats, etc. for any cracks. If items are cracked in an unsafe manner, take photos and contact Greenfields to order new pieces.
- Check all rubber grips for any signs of wear, and make sure they are functioning correctly. If grips are torn or cut, exposing handlebars, take photos and report to Greenfields.
- Inspect welds for any signs of wear. If there is any damage, take photos and report to Greenfields.
- Check round safety labels for any signs of wear or vandalism, and send photos if there is.
- If unsafe for public use, please wrap portion of that unit with a caution-tape to prevent use while maintenance is in progress.

#### Internal Inspection

- Engage moving parts and ensure full, uninhibited functionality. If units are making noises when in use, do NOT lubricate the bearings. Check for any metal on metal contact and send photos to Greenfields for review.
- Inspect bolts and caps to ensure equipment is fully tightened. If screws are loose or missing, tighten or install new screws using a thread-locking compound. If new screws are needed, take photos of the location they are needed and contact Greenfields to order new screws.
- If unsafe for public use, please wrap portion of that unit with caution tape to prevent use while maintenance is in progress.

#### Documentation

- Greenfields takes great pride in providing amazing outdoor fitness gyms that are intended for use by the unsupervised masses in public settings. We do realize that left unattended, units may be subject to improper use or even abuse. We rely on the local maintenance staff to provide the necessary support in order to keep all units and parts in optimal operating condition for years to come.
- Please use the inspection log provided.

#### Reporting

- Greenfields Customer Support Center is available to help with all inquiries. **Please feel free to contact us at: [csc@greenfieldsfitness.com](mailto:csc@greenfieldsfitness.com) or 888-315-9037 x 105**
- Please be sure to include photos and name of the park, city, state, country and on-site contact person with whom to communicate.

In order to honor our commitment to quality and safety, Greenfields Outdoor Fitness reserves the right to make changes and revise the design specifications without notice.  
© 2022 Greenfields Outdoor Fitness, Inc.

## Safety and Upkeep Information



Greenfields Outdoor Fitness equipment is intended to be used by the unsupervised public in a variety of outdoor settings. Greenfields is extremely proud of the safe and durable design of its products, which are built to surpass their warranty under normal usage. Installations throughout the hemisphere prove this equipment's success in both hot and cold climates, as well as dry and humid conditions. While the units are designed to be, for the most part, maintenance free, Greenfields recognizes that heavy and constant usage will require a minimal level of maintenance.

Greenfields recommends periodic visual inspections of all outdoor fitness equipment to ensure that each unit is functioning normally and safely. In environments prone to vandalism, local maintenance teams should inspect more frequently. Periodic inspection is at the owners' discretion. Greenfields' Inspection Checklist is a suggestion only and is not intended to replace owners' own internal inspection system.

The following information is intended to provide some guidance for local maintenance teams:

#### Age Appropriate Use

This fitness equipment is classified as Adult Fitness Equipment and is designed to be used by individuals 14 years or older. Please take necessary precautionary steps to prevent use (and mis-use) by individuals younger than 14. Parental supervision should be enforced.

#### Normal Wear & Tear

As with any equipment, certain parts may wear more rapidly due to the type and frequency of usage. Most of Greenfields' replacement parts are designed to be installed easily—with specific instructions provided as needed. Every owners' manual contains a detailed replacement parts list for each unit purchased. [Please be advised that the use of decomposed granite (DG) is known to increase the normal wear of footrests and platforms. DG particles attach to the soles of shoes and, like sandpaper, grind these surfaces continually.]

#### Surface Touch-up

During handling and/or installation, the various surfaces of the equipment may become scratched or disfigured. Greenfields provides touch-up paint with each shipment, and a "Touch-up Guide" is included in this manual. Greenfields' support staff is always available to answer questions regarding the above.

#### Vandalism

Greenfields' equipment is installed in all types of environments. In some cases, these installations face the challenges of vandalism, graffiti, theft, etc. In some instances touch-up paint is a simple remedy; in other cases a replacement part may have to be purchased. While the warranty does not cover cases of vandalism, Greenfields' customer service team will strive to resolve issues quickly and fairly.

#### Improper Usage

Since Greenfields' equipment is used without supervision, it may be subject to improper use—that for which it was not designed. Over the years, through its R&D efforts, Greenfields has been able to modify the equipment design to minimize damages caused by improper use. Nevertheless, improper use may compromise a unit's integrity, leading to unnecessary repair expense and/or unsafe conditions. Signs of improper use can sometimes be detected through visual inspections.

In order to honor our commitment to quality and safety, Greenfields Outdoor Fitness reserves the right to make changes and revise the design specifications without notice.  
© 2022 Greenfields Outdoor Fitness, Inc.



# WARRANTY

## WARRANTY

- Limited 10-year warranty on main posts and metal structures
- Limited 5-year warranty on moving parts and bearings
- Limited 5-year warranty on seats and backrests
- Limited 3-year warranty on hydraulic pistons
- Limited 2-year warranty on footrests, armrests, rubber parts, and chains
- Limited 1-year warranty on battle ropes, climbing ropes, and suspension trainers

All warranties cover failure due to natural deterioration or manufacturing defects and do not include any cosmetic issues or wear and tear from normal use. This warranty does not cover cosmetic items such as scratches, dents, marring, fading, discoloring, weathering, wear and tear, or normal level of rusting. Warranty is valid only if the equipment is installed and maintained in conformity with Greenfields' installation and maintenance procedures furnished by Greenfields Outdoor Fitness. Equipment should not be exposed to any irrigation, especially with reclaimed water, as this will void the warranty. Equipment must be installed on a surface with proper drainage and or slope to prevent water buildup around the base of the equipment. Equipment should not be installed in basins or in low-lying areas which result in equipment being submerged. Equipment should be installed in a timely fashion after delivery; however, if the equipment must be stored for an extended period of time, crates should be stored in a dry, indoor environment.

## OTHER PRODUCT INFORMATION

Greenfields will continue to develop its line of products and therefore reserves the right to change the design specifications without notice. The equipment is designed for use by individuals weighing up to 300 pounds. The equipment is NOT intended to be used by individuals younger than 14 years of age unless supervised by adults. Greenfields' units are designed to accommodate the majority of users age 14 and above; however, due to the nature of outdoor fitness equipment, units are regarded as "one size fits most, but not all."

## CUSTOMER SUPPORT

Upon written notification (email or fax) to Greenfields of a product's failure to conform to any of the aforementioned warranties during the applicable warranty period, Greenfields shall correct such failure/nonconformity by repairing the defective part(s) or providing replacement part(s) within 60 calendar days of receipt of the notification. Greenfields shall ship the required replacement part(s) to the site free of charge, but will not be responsible for providing labor or the cost of labor for removing defective part(s) or installing replacement part(s). Greenfields will warranty the replacement part(s) for the remainder of the original warranty period. Furthermore, no representation, oral or written, of any individual may be substituted for this exclusive limited warranty.

To the extent permitted by law, Greenfields shall not be liable for any direct, indirect, special, incidental or consequential damages, which are expressly excluded from the sale of its product. To make claims under the terms of this warranty, please contact Greenfields' Customer Support Center at CSC@GreenfieldsFitness.com. Please include photos or video.

## INSTALLATION

Greenfields' equipment is constructed from heavy steel pipes and is subject to heavy forces and torques when in use as intended. Extra care must be taken to ensure that the equipment is securely installed so that it can be safely enjoyed for years to come. There are two methods of installation for the equipment:

- Surface mount installation with posts bolted to a reinforced concrete slab a minimum of 6"-8" thick (please refer to Installation Instructions & Video for detailed guidelines)
- Permanent in-ground installation in which the equipment post extensions are placed in concrete footings and use provided rebar pegs (please refer to Installation Instructions & Video for detailed guidelines)

Installers and project managers are encouraged to contact Greenfields' Customer Support Center with any questions before, during, and/or after installation. Detailed installation instructions are available for all products and are included in the Operations & Maintenance (O&M) Owner's Manuals which are shipped with every order. Often the installation of Greenfields' products is assigned to the lowest bidding contractor. The contractor may not have been in contact with Greenfields prior to the project or seen the detailed Installation Instructions. It is the responsibility of the project manager to ensure installing contractor is provided with the most updated set of Greenfields' Installation Instructions & Installation Video to ensure the validity of the warranty. Should the project installer need a copy of the Installation Instructions, please contact Greenfields' Customer Support Center at 888-315-9037 x105 or by email at CSC@GreenfieldsFitness.com.

## SAFETY STANDARDS

This adult outdoor fitness equipment is not intended for use by unsupervised individuals younger than 14 years of age. ASTM recently adopted ASTM F3101-21A Standard Specification for Unsupervised Public Use Outdoor Fitness Equipment. While playgrounds are subject to laws in various states requiring compliance with ASTM and/or Consumer Product Safety Commission (CPSC) guidelines, at time of this publication, and to the best knowledge of Greenfields Outdoor Fitness, there are no state laws requiring compliance with standards set forth by ASTM for outdoor fitness equipment (nor with CPSC guidelines, as none currently exist.) Play equipment can be certified to be in compliance with ASTM by the International Playground Equipment Manufacturers Association (IPEMA), and many agencies have a requirement that they only purchase equipment that is IPEMA certified.

However, at this time, this is not possible with outdoor fitness equipment, as IPEMA does not currently certify compliance of outdoor fitness equipment. In addition, at this time there are no programs in place to train certified inspectors for outdoor fitness equipment. Without a state law that requires compliance, specifications are voluntary only. However, Greenfields Outdoor Fitness strives to comply with all of the voluntary specifications of ASTM F3101-21A. Greenfields recommends adding a customized sign to each project to limit liability.

## SURFACING MATERIALS

Over the years, Greenfields' product has been installed using the following various types of surfacing. ASTM 3101-21A suggests impact attenuating surfacing for some scenarios. The type of surfacing used is ultimately the choice of the owner and their project manager. When it comes to Functional Fitness, Challenge Course and any other apparatus with an overhead structure, it is advised to use fall attenuating surfacing. Greenfields does not promote the use of one type of surfacing over another – the decision is ultimately up to project owners and their architects / engineers. For project specific information, please feel free to contact a Greenfields project manager.

## MAINTENANCE & EQUIPMENT UPKEEP

Greenfields Outdoor Fitness equipment is intended to be used by the unsupervised public in a variety of outdoor settings. Greenfields is extremely proud of the safe and durable design of its products, which are built to surpass their warranty under normal usage. Installations worldwide prove this equipment's success in both hot and cold climates, as well as dry and humid conditions. While the units are designed to require, for the most part, little to no maintenance, Greenfields recognizes that heavy and constant usage will require a minimal level of maintenance which will be scheduled based on the specific nature of each project. Installation on an ocean front, or with a direct line of sight to the ocean, will expose the units to salt and will require additional maintenance which is not required at inland sites or in dry climates. Such installations will require a regular freshwater rinse to remove the salt from the units (do not use reclaimed water - exposing the equipment to reclaimed water will void warranty). Greenfields recommends periodic inspection by a maintenance team to ensure each and every apparatus functions as intended. Please refer to the Periodic Inspection Checklist provided with the O&M Owner's Manuals. For project specific information, please feel free to contact a Greenfields project manager.