



# 2024 SCHOOL PACKAGE 1

11 UNITS 26 USERS





11 UNITS 26 USERS

# 2024 SCHOOL PACKAGE 1



CARDIO



STRENGTH



STRETCHING



FUNCTIONAL FITNESS



MULTI GENERATIONAL



LARGE AREA

## UNITS

- SGR033 Multi-Level Bars
- SGR014 2-Person Dips Station
- SGR019 2-Person Incline Sit-Up Bench
- SGR042 2-Person Back & Arms Combo
- SGR047 2-Person Vertical Press
- SGR048 2-Person Lat Pull
- SGR048A 2-Person Chest Press
- SHP510 4-Person Combo Bars
- SHP724 Plyometric Steps (Set of 3)
- UBX360 (x2) Balancing Plate
- SGR105 Customized Announcement Sign

## PACKAGE SPECS

UNITS	11
USERS	26
REQUIRED DIMENSIONS	47' x 40'

## Available options:

- Announcement sign customization - layout, text and graphics 100% customizable on both sides
- Shade
- Site amenities

## Activities for entry-level to advanced students

Greenfields' School Package 1 is ideal for both P.E. classes and out-of-classtime recreation. This basic package can accommodate over 50 students when used in conjunction with supplemental cardio activities.

Due to the height of some of the components in this package, Greenfields recommends the use of fall attenuating surfacing.



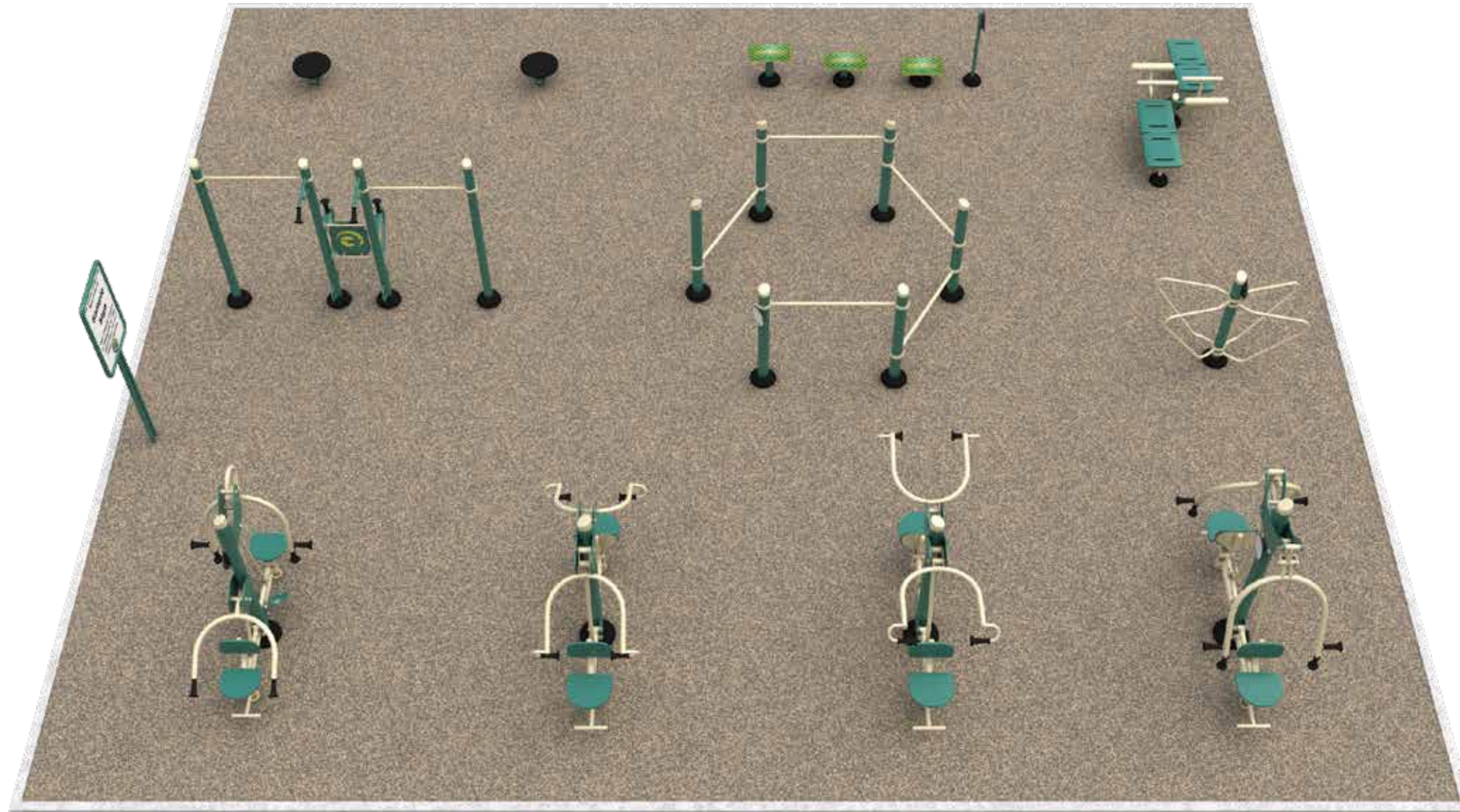

Due to the height of some of the components in this package, Greenfields recommends the use of fall attenuating surfacing.





Due to the height of some of the components in this package, Greenfields recommends the use of fall attenuating surfacing.

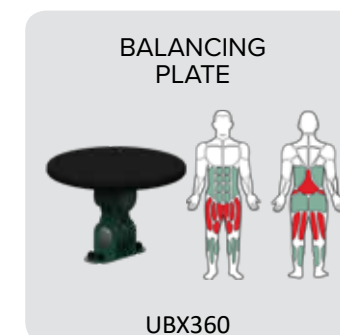
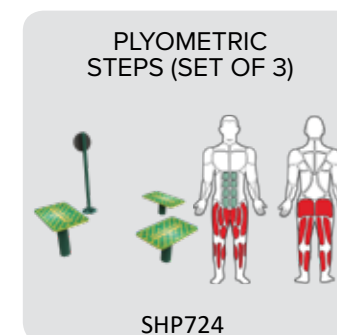
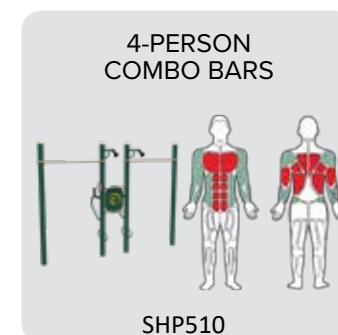
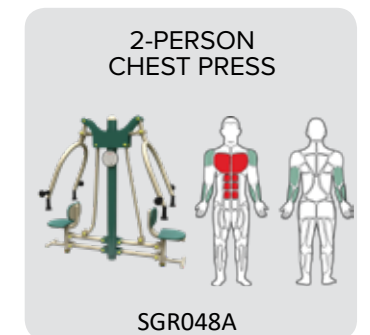
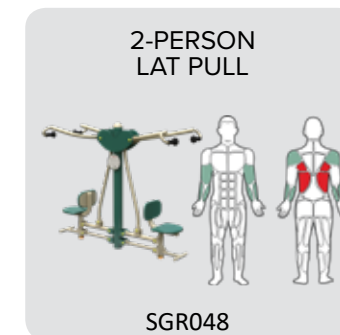
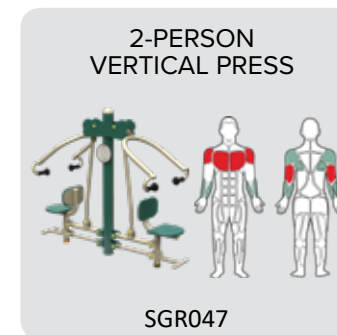
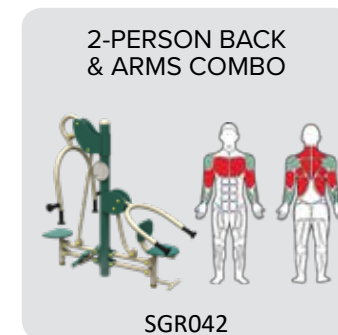
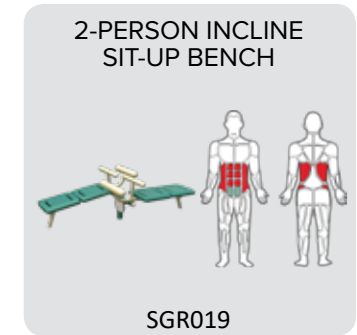
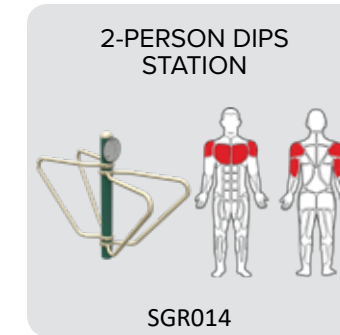
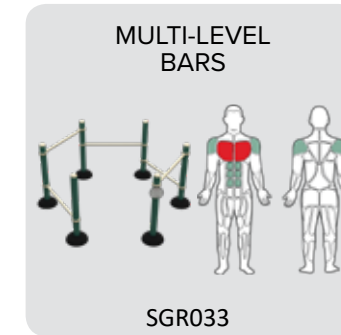
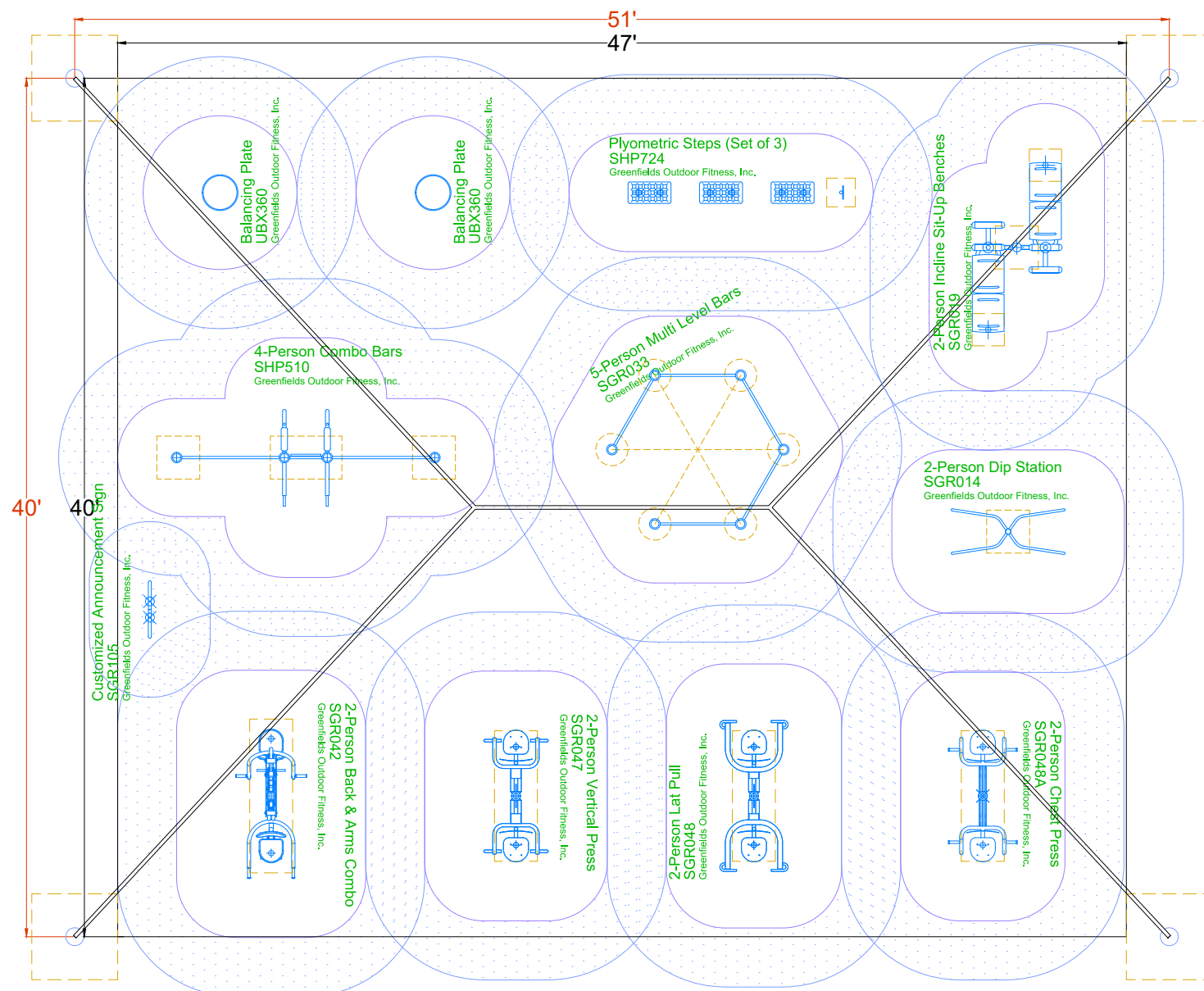

Due to the height of some of the components in this package, Greenfields recommends the use of fall attenuating surfacing.

**Greenfields' preferred method of installation is surface mount. In-ground direct bury option is available upon request.**





## UNIT LIST

- SGR033 Multi-Level Bars
- SGR014 2-Person Dips Station
- SGR019 2-Person Incline Sit-Up Bench
- SGR042 2-Person Back & Arms Combo
- SGR047 2-Person Vertical Press
- SGR048 2-Person Lat Pull
- SGR048A 2-Person Chest Press
- SHP510 4-Person Combo Bars
- SHP724 Plyometric Steps (Set of 3)
- UBX360 (x2) Balancing Plate
- SGR105 Custom Announcement Sign

**These 11 units may serve up to 26 people at a time.**

Please be advised that the use of DG (Decomposed Granite) increases the normal wear & tear of all footrests and other platforms used by the users.

*“Most kids would like to address their fitness levels, but they don’t know how or they’re not given the right opportunity. Greenfields gives them that opportunity.”*

*~ Todd Harvey  
Coach & PE Teacher  
Reach Academy*



<http://www.gfoutdoorfitness.com/school-fitness.html>



# ENHANCE YOUR PACKAGE!

Greenfields offers these products and more for the best user experience



Benches



Trash Receptacles



Bike Racks



**What's underneath?**  
Integrated lighting allows  
for use well into the  
evening.

## SHADE OPTIONS

Designed to fit your project's  
unique needs



Shade sails



Multi-level shade



Shade canopy





Unit labels feature safety guidelines, exercise instructions and more!

**2-Person Accessible Lat Pull**  
**SGR048W**

**FUNCTION:**  
Strengthens back muscles, shoulders, and arm muscles

**INSTRUCTIONS:**  
(With wheelchair) Maneuver chair so back and bottom of seat are close to but not touching unit. Lock wheels. (Without wheelchair) Sit on seat with back against back rest and feet on footpegs. Grip handles and pull towards shoulders. Hold and return to start position.

Greenfields' units are designed to accommodate the majority of users age 14 and above; however, due to the nature of outdoor fitness equipment, units are "one size fits most."

**VIDEO DEMO**

Target muscles in red  
Secondary muscles in green

**User Guidelines**  
This fitness equipment is designed for your enjoyment. For your safety, we ask you to comply with the following:

- You must be at least 14 years old to use this apparatus.
- Parents / Guardians: Do not let your underage children on this equipment.
- User assumes all risk and responsibility for using this exercise equipment.
- Consult a physician prior to starting any physical fitness training program. Potential users with known adverse health conditions should not use this equipment. Before using the equipment, check for loose parts, breaks, cracks or other conditions needing attention.
- Perform exercises according to instructions on each piece of the equipment.
- Breathe normally during physical activity.
- Perform resistance exercises according to instructions in a slow, controlled manner over the full range of motion. Performing the movements too quickly may result in an injury. Use the equipment only with your capabilities.
- Pay attention to how your body feels. In the event that pain or discomfort occurs, STOP THE EXERCISE IMMEDIATELY and consult your physician.
- Rest and recovery are important between sets and exercises. Allow 2 minutes of rest between sets of exercises or sessions.
- Keep fingers, toes, and hair or other non-participant body parts away from equipment elements during exercise.
- Keep a safe distance from exercise equipment when in use by others.

Greenfields Outdoor Fitness, Inc. shall not be liable for any personal injury to any person resulting from the use of this exercise equipment.

L00019

[www.SignatureAccessible.com](http://www.SignatureAccessible.com)  
888-315-9037



## CUSTOMIZED ANNOUNCEMENT BOARD SGR105

This announcement board can be used to:

- State safety guidelines
- Acknowledge project donors/sponsors
- Encourage healthy lifestyle choices
- Provide sample workouts

Customization available at no charge  
(text, logos, etc.)

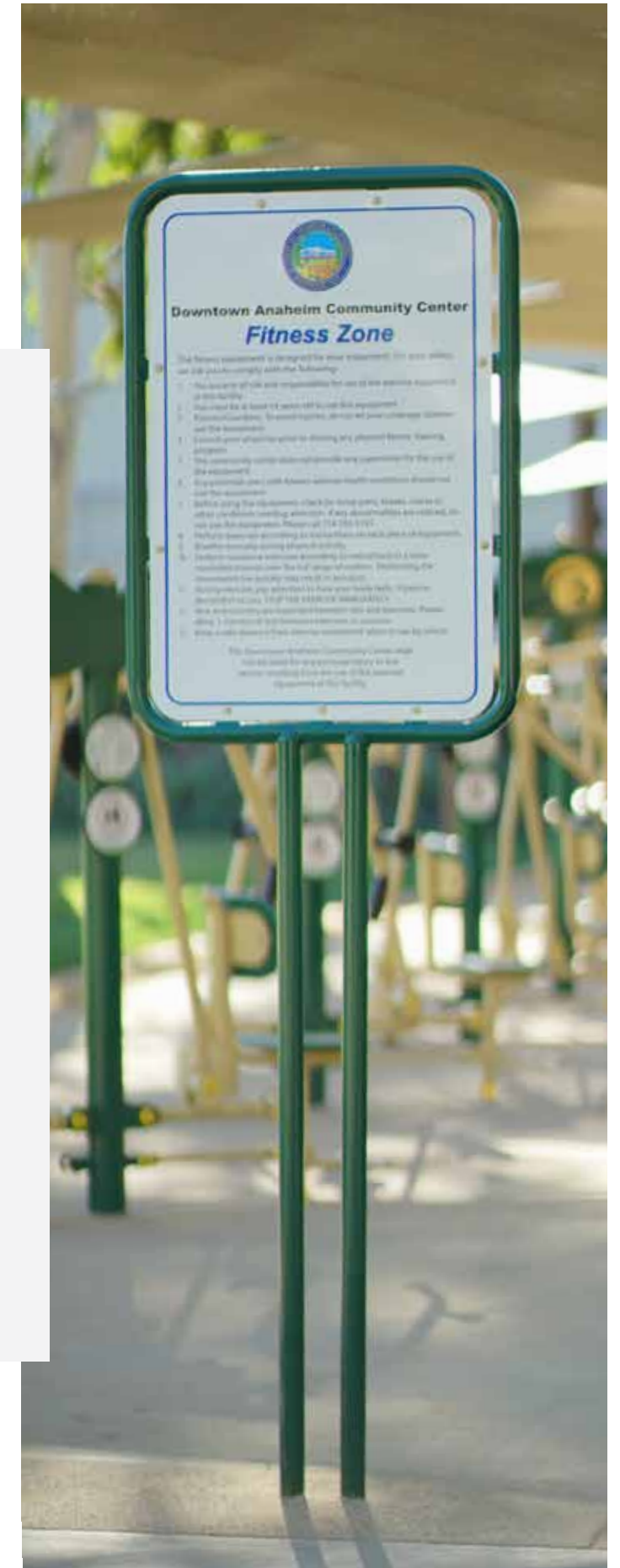
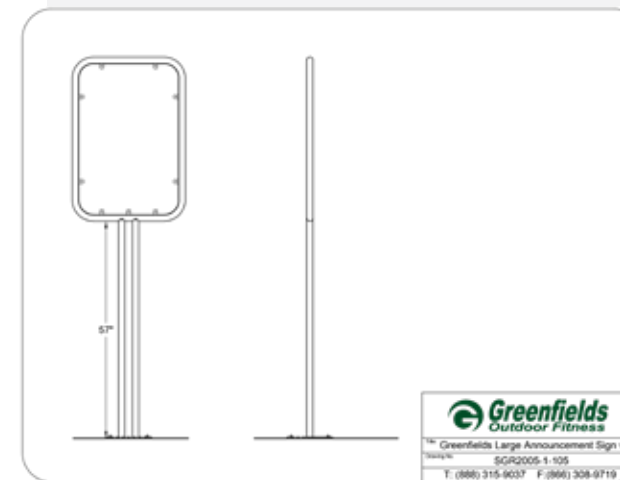



# THE GREENFIELDS OUTDOOR FITNESS APP

The Greenfields App is the perfect companion to our multigenerational outdoor gyms, giving users the ability to search for gyms near their location, explore exercises available on Greenfields units, create workouts, and log their progress.

Now available on iOS and Android.



[greenfieldsfitness.com/app-download/](https://greenfieldsfitness.com/app-download/)

## EXPLORE

Search for gyms near you.



## WORKOUT

Customize your routine.

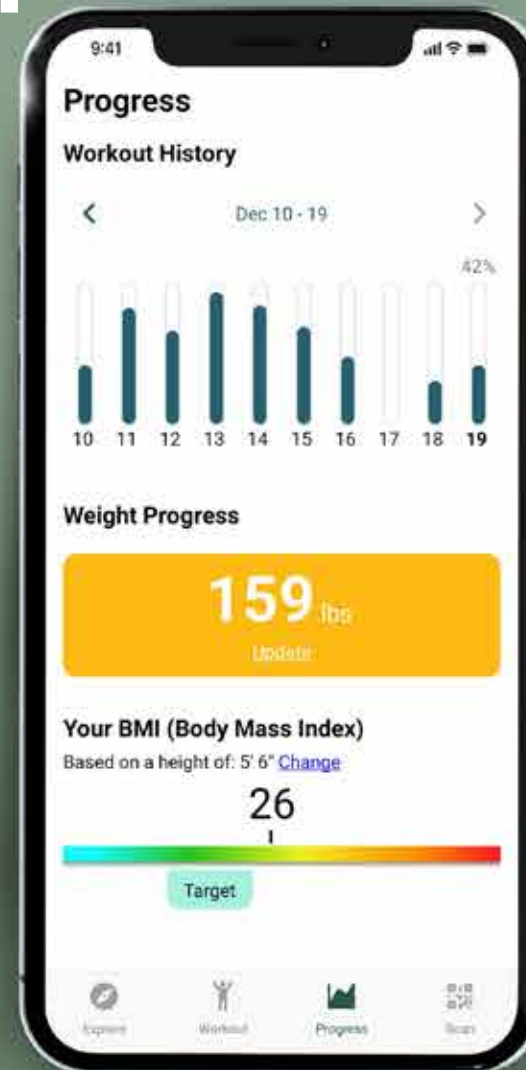

## SCAN

Quickly find videos & more.





## General Installation Instructions: Surface Mount



The following information for contractors, maintenance personnel and supervisory staff will help ensure an accurate, safe and problem-free installation. **UNITS ARE HEAVY** (up to 450 lbs.) When unloading and handling, please exercise extra care to prevent injury or damage to the equipment. For installation, epoxy is **not** included in shipment and must be provided by installer.

Questions? Please call 888-315-9037 x105

installation. **UNITS ARE HEAVY** (up to 450 lbs.) When unloading and handling, please exercise extra care to prevent injury or damage to the equipment. For installation, epoxy is **not** included in shipment and must be provided by installer.



Video Demo: <http://www.greenfieldsfitness.com/surface-mount-installation/>

### Tools Needed: **Concrete pad must be fully cured before anchoring begins.**

1. Concrete drill
2. 1/2" carbide tipped drillbit
3. Angle grinder
4. Compressor with blow tip
5. Sledge hammer
6. 3/4" socket
7. Torque wrench

### Parts Included:

Wedge Anchors - 4 1/2" x 1/2"

Black Plastic Covers

Black Plastic Caps

Metal Shims

#### Specifications:

- Concrete: 3250 PSI (minimum)
- Aggregate mix: 1:3 3/8" to 3/4"
- Concrete mix: 1:3:2.5 concrete, aggregate, and sand mix
- #3 rebar with 12" spacing
- When pouring a single pad for multiple units, **use concrete thickness 6"**
- When pouring standalone pads, **concrete thickness minimum 8"**
- Bolt Size: 1/2"
- Bolt Length: 4-1/2" (minimum)
- Hardware: Wedge Anchor Stainless Steel
- Minimum embed depth: 3-1/2"

### Basic Installation Guidelines:



1. Place unit on concrete pad and mark holes. Mark all holes. Make a mark on the unit and the ground to make sure unit lines up with holes.



2. Drill all holes with concrete drill. Drill to a depth of 5-6" deep.



3. Using compressor or blower, blow out concrete dust from holes.



4. Fill holes with epoxy, making sure not to overfill. (Epoxy is **not** included in shipment and must be provided by installer).

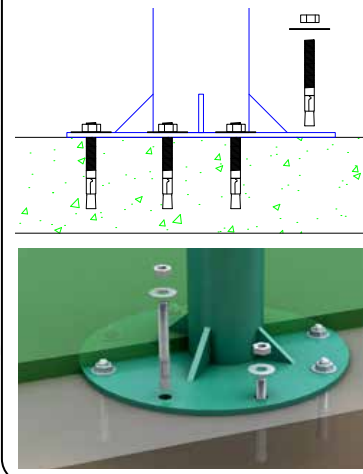

In order to honor our commitment to quality and safety, Greenfields Outdoor Fitness reserves the right to make changes and revise the design specifications without notice.  
LU21x03x24 © 2020 Greenfields Outdoor Fitness, Inc.

## General Installation Instructions: Surface Mount



The following information for contractors, maintenance personnel and supervisory staff will help ensure an accurate, safe and problem-free installation.

Questions? Please call 888-315-9037 x105

### Basic Installation Guidelines (cont'd)



5. Place unit over holes and make sure it lines up with mark.
6. Thread nuts onto anchors just until they are flush with the top of the anchors.
7. Hammer anchors into holes.
8. Install shims to plumb posts.
9. Tighten anchors until snug, and wait 24 hours to tighten to 80-90ft/lbs.
10. Cut off extra bolt length, if any.
11. Follow unit-specific installation instructions for installation of base plate covers and black caps.

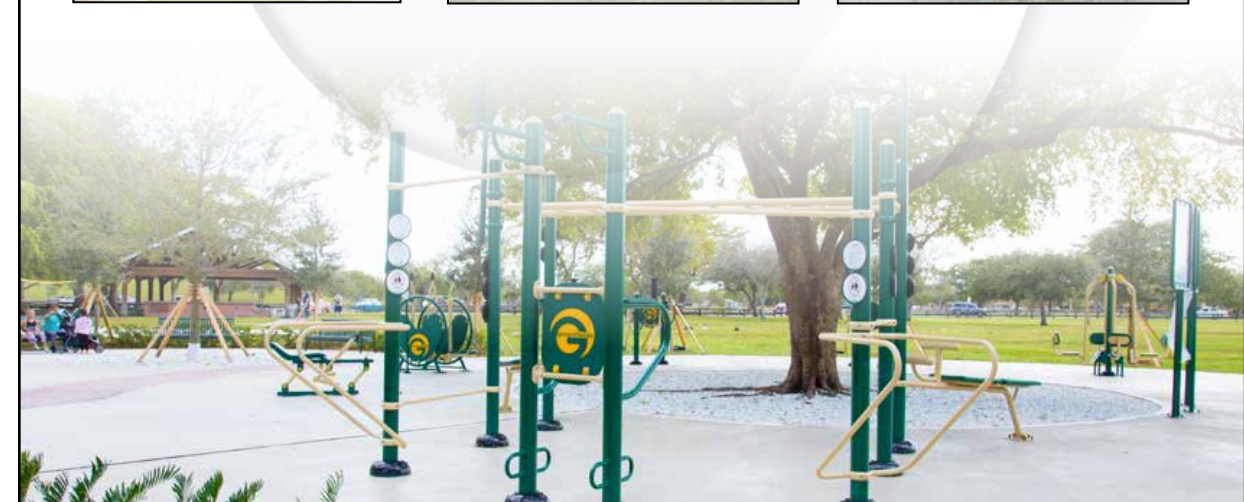



# SURFACE MOUNT WITH PIP DRAINAGE OPTIONS

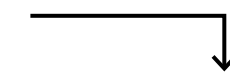

**French Drain #1**

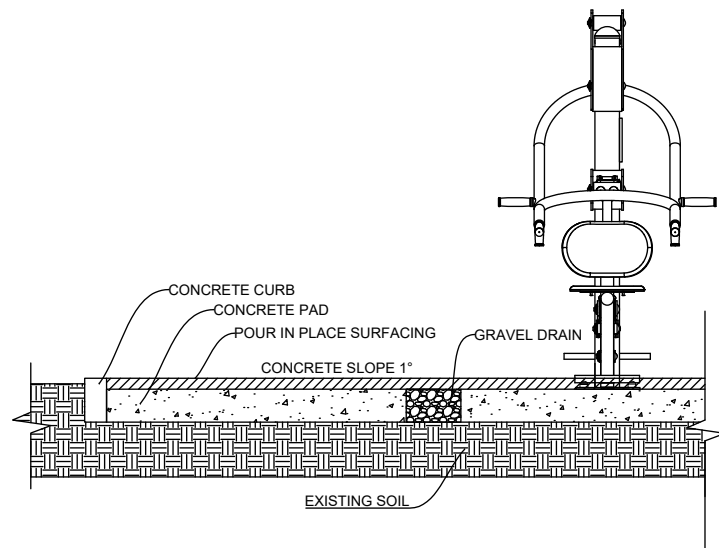

**Curb Cutouts**

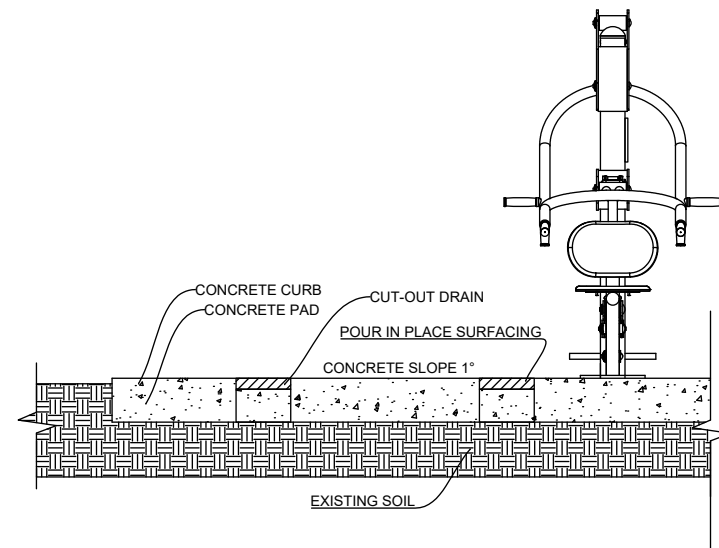

**PIP Wrap-Around**

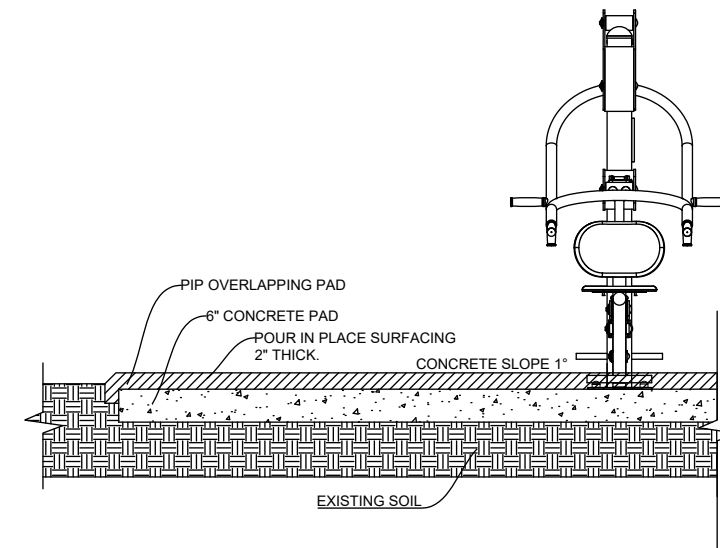

**French Drain #2**

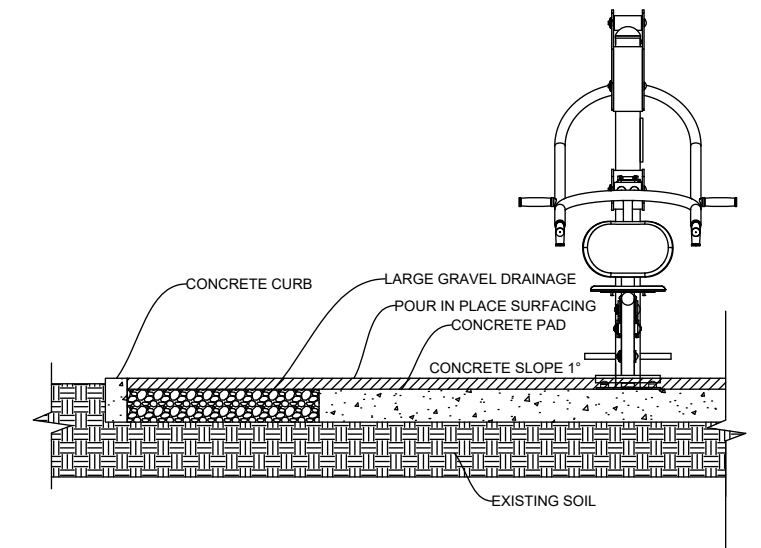



## Inspection Checklist

### General Guidelines for Outdoor Fitness Equipment



Questions? Please call 888-315-9037 x105

The following document is supplied as a general inspection document to be performed during regular park inspections. Our support team can be reached at (888) 315-9037 x105 or [csc@greenfieldsfitness.com](mailto:csc@greenfieldsfitness.com).

#### Inspection process

- Visual Inspection
- Internal Inspection
- Documentation
- Reporting

#### Visual Inspection

- Check all plastic footrests, backrests, seats, etc. for any cracks. If items are cracked in an unsafe manner, take photos and contact Greenfields to order new pieces.
- Check all rubber grips for any signs of wear, and make sure they are functioning correctly. If grips are torn or cut, exposing handlebars, take photos and report to Greenfields.
- Inspect welds for any signs of wear. If there is any damage, take photos and report to Greenfields.
- Check round safety labels for any signs of wear or vandalism, and send photos if there is.
- If unsafe for public use, please wrap portion of that unit with a caution-tape to prevent use while maintenance is in progress.

#### Internal Inspection

- Engage moving parts and ensure full, uninhibited functionality. If units are making noises when in use, do NOT lubricate the bearings. Check for any metal on metal contact and send photos to Greenfields for review.
- Inspect bolts and caps to ensure equipment is fully tightened. If screws are loose or missing, tighten or install new screws using a thread-locking compound. If new screws are needed, take photos of the location they are needed and contact Greenfields to order new screws.
- If unsafe for public use, please wrap portion of that unit with caution tape to prevent use while maintenance is in progress.

#### Documentation

- Greenfields takes great pride in providing amazing outdoor fitness gyms that are intended for use by the unsupervised masses in public settings. We do realize that left unattended, units may be subject to improper use or even abuse. We rely on the local maintenance staff to provide the necessary support in order to keep all units and parts in optimal operating condition for years to come.
- Please use the inspection log provided.

#### Reporting

- Greenfields Customer Support Center is available to help with all inquiries. **Please feel free to contact us at: [csc@greenfieldsfitness.com](mailto:csc@greenfieldsfitness.com) or 888-315-9037 x 105**
- Please be sure to include photos and name of the park, city, state, country and on-site contact person with whom to communicate.

In order to honor our commitment to quality and safety, Greenfields Outdoor Fitness reserves the right to make changes and revise the design specifications without notice.  
© 2022 Greenfields Outdoor Fitness, Inc.

## Safety/Maintenance Inspection Log



Date	Location	Unit(s)	Describe Issue/ Action Taken	Name	Follow-up



# WARRANTY

- Limited 10-year warranty on main post and metal structure
- Limited 5-year warranty on moving parts and bearings
- Limited 5-year warranty on seats and backrests
- Limited 3-year warranty on hydraulic pistons
- Limited 2-year warranty on footrests, armrests, rubber parts, and chains
- Limited 1-year warranty on battle ropes, climbing ropes, and suspension trainers

All warranties cover failure due to natural deterioration or manufacturing defects and do not include any cosmetic issues or wear and tear from normal use. This warranty does not cover cosmetic items such as scratches, dents, marring, fading, discoloring, weathering, wear and tear, or normal level of rusting. Warranty is valid only if the equipment is installed and maintained in conformity with Greenfields' installation and maintenance procedures furnished by Greenfields Outdoor Fitness. Equipment should not be exposed to any irrigation, especially with reclaimed water, as this will void the warranty. Equipment must be installed on a surface with proper drainage and or slope to prevent water buildup around the base of the equipment. Equipment should not be installed in basins or in low-lying areas which result in equipment being submerged. Equipment should be installed in a timely fashion after delivery; however if the equipment must be stored for an extended period of time, crates should be stored in a dry, indoor environment.

## OTHER PRODUCT INFORMATION

Greenfields will continue to develop its line of products and therefore reserves the right to change the design specifications without notice. The equipment is designed for use by individuals weighing up to 300 pounds. The equipment is NOT intended to be used by individuals younger than 14 years of age unless supervised by adults. Greenfields' units are designed to accommodate the majority of users age 14 and above; however, due to the nature of outdoor fitness equipment, units are regarded as "one size fits most, but not all."

## CUSTOMER SUPPORT

Upon written notification (email or fax) to Greenfields of a product's failure to conform to any of the aforementioned warranties during the applicable warranty period, Greenfields shall correct such failure/nonconformity by repairing the defective part(s) or providing replacement part(s) within 60 calendar days of receipt of the notification. Greenfields shall ship the required replacement part(s) to the site free of charge, but will not be responsible for providing labor or the cost of labor for removing defective part(s) or installing replacement part(s). Greenfields will warranty the replacement part(s) for the remainder of the original warranty period. Furthermore, no representation, oral or written, of any

individual may be substituted for this exclusive limited warranty. To the extent permitted by law, Greenfields shall not be liable for any direct, indirect, special, incidental or consequential damages, which are expressly excluded from the sale of its product. To make claims under the terms of this warranty, please contact Greenfields' Customer Support Center at CSC@GreenfieldsFitness.com. Please include photos or video.

## INSTALLATION

Greenfields' equipment is constructed from heavy steel pipes and is subject to heavy forces and torques when in use as intended. Extra care must be taken to ensure that the equipment is securely installed so that it can be safely enjoyed for years to come.

There are two methods of installation for the equipment:

- Surface mount installation with posts bolted to a reinforced concrete slab a minimum of 6"-8" thick (please refer to Installation Instructions & Video for detailed guidelines)
- Permanent in-ground installation in which the equipment post extensions are placed in concrete footings and use provided rebar pegs (please refer to Installation Instructions & Video for detailed guidelines)

Installers and project managers are encouraged to contact Greenfields' Customer Support Center with any questions before and/or after installation. Detailed installation instructions are available for all products and are included in the Operations & Maintenance (O&M) Owner's Manuals which are shipped with every order.

Often the installation of Greenfields products is assigned to the lowest bidding contractor. The contractor may not have been in contact with Greenfields prior to the project or seen the detailed Installation Instructions. It is the responsibility of the project manager to ensure installing contractor is provided with the most updated set of Greenfields' Installation Instructions & Installation Video to ensure the validity of the warranty.

Should the project installer need a copy of the Installation Instructions, please contact Greenfields' Customer Support Center at 888-315-9037 x105 or by email at CSC@GreenfieldsFitness.com.

## SAFETY STANDARDS

This adult outdoor fitness equipment is not intended for use by unsupervised individuals younger than 14 years of age. ASTM recently adopted ASTM F3101-15 Standard Specification for Unsupervised Public Use Outdoor Fitness Equipment. While playgrounds are subject to laws in various states requiring compliance with ASTM and/or Consumer Product Safety Commission (CPSC) guidelines, at time of this publication, and to the best knowledge of the author, there are no state laws requiring compliance with standards set forth by ASTM for outdoor fitness equipment (nor with

CPSC guidelines, as none currently exist.) Play equipment can be certified to be in compliance with ASTM by the International Playground Equipment Manufacturers Association (IPEMA), and many agencies have a requirement that they only purchase equipment that is IPEMA certified. However, at this time, this is not possible with outdoor fitness equipment, as IPEMA does not currently certify compliance of outdoor fitness equipment. In addition, at this time there are no programs in place to train certified inspectors for outdoor fitness equipment. Without a state law that requires compliance, specifications are voluntary only. However, Greenfields Outdoor Fitness strives to comply with all of the voluntary specifications of ASTM F3101-15. Greenfields recommends adding a customized sign to each project to limit liability.

## SURFACING MATERIALS

Over the years, Greenfields' product has been installed using the following types of surfacing: decomposed granite (aka DG or crushed granite), concrete, bonded rubber or poured-in-place surfacing, rubber tiles, asphalt, paver stones, and synthetic grass. Mulch, woodchips, beach sand, and sod have also been used but are not recommended with respect to wheelchair access. The type of surfacing used is ultimately the choice of the owner and their project manager. When it comes to Greenfields Functional Fitness Series, it is advised to use fall attenuating surfacing.

## MAINTENANCE & EQUIPMENT UP KEEP

Greenfields Outdoor Fitness equipment is intended to be used by the unsupervised public in a variety of outdoor settings. Greenfields is extremely proud of the safe and durable design of its products, which are built to surpass their warranty under normal usage. Installations throughout the hemisphere prove this equipment's success in both hot and cold climates, as well as dry and humid conditions. While the units are designed to require, for the most part, little to no maintenance, Greenfields recognizes that heavy and constant usage will require a minimal level of maintenance which will be scheduled based on the specific nature of each project.

Installation on an ocean front, or with a direct line of sight to the ocean, will expose the units to salt and will require additional maintenance which is not required at inland sites or in dry climates. Such installations will require a regular fresh water rinse to remove the salt from the units (do not use reclaimed water - exposing the equipment to reclaimed water will void warranty). Greenfields recommends periodic inspection by a maintenance team to ensure each and every apparatus functions as intended. Please refer to the Periodic Inspection Checklist provided with the O&M Owner's Manuals.